

Specifications

When designing an opening - Ensure the opening is plumb and true. There should be sufficient room at the front and rear of the opening for projection, as well as adequate pulley and nib room.

Standard design - Doors are constructed from rectangular hollow steel sections and suitably braced for minimum deflection in the open and closed position. The standard design is based on 0.5kPa wind load. This may be altered to suit particular situations. Thus the desired wind load must be stated, when specifying this product.

Size

Maximum width: 30 metres

Maximum height: 8 metres

Cladding (Steel) - Doors can be clad with various sheeting materials. Standard Colorbond profiles are commonly used however specialised profiles can be used. Please consult the manufacturer on the use of non standard sections.

Cladding (Glass) - Doors can be partially or fully glazed for viewing or showroom display and are glazed in accordance with AS1288. Standard glazing uses 6.38mm laminated safety glass. The use of other glass or glazing material should be referred to the manufacturer due to additional weight, deflection, door design and construction. Glazed doors will generally incorporate a kickplate in the base of the bottom leaf. Door size and weight will determine kickplate height.

Bar Grille - This door is constructed of standard RHS frame covered with 20mm square hollow steel tube welded vertically over the entire door face at approximately 120mm centres.

Other Cladding - Other available cladding commonly used are plywood, mesh, perforated sheet, woven wire and galvanised sheet.

Finishes - Standard finish on frames and channels is epoxy primed and polyurethane. On glazed doors beading can be anodised or powdercoat finish. Other finishes are available if required, please specify.

Locking - By use of internal padbolts unless otherwise specified. Motorised doors will not be fitted with locks.

Counterweight Covers - The counterweights shall be protected and covered with a removable pressed sheet to meet design requirements.



Patent Pending No. 243258



Optional Extras

Escape and Access Doors - Can be incorporated into door design providing bottom leaf height is sufficient. Locking is by a night latch unless otherwise specified. It is recommended that access doors open inward on a Series 3000 door.

Motorisation - Operation by a ramp and carriage designed for smooth opening and closing. The carriage is driven by an overhead shaft connected to a three or single phase drive unit incorporating open and close limit switches. Doors may be electronically operated and fitted with sophisticated control systems as required. Advise whether doors are to be designed for future electric operation.

Renlita Overhead Doors has a continuous program of product development and reserves the right to change specifications at any time without notice.

Contact Details

NSW Office

58 Box Road, Taren Point NSW 2229
Phone: (02) 9526 1222 Fax: (02) 9525 1114

QLD Office

56/58 Nestor Drive, Meadowbrook QLD 4131
Phone: (07) 3805 7314 Fax: (07) 3805 7315
QBSA Act Licence No. 1004980

VIC Office

39 Nicholas Drive, Dandenong South VIC 3175
Phone: (03) 9768 2562 Fax: (03) 9768 2563

WA / SA Office

Phone: 0414 810 274 Fax: (08) 6210 1508

Visit our website: www.renlita.com.au

Renlita Overhead Doors

Counterweight Balanced Door

The Renlita Foldaway Series 3000 Counterweight Balanced Door spans up to 30 metres to make an outstanding statement.

With the capacity to accept a wide variety of sizes, claddings and glazing patterns, they have the potential to radically showcase your building.

This door is designed to suit most commercial and industrial applications. It is widely used in mines, fire stations, ambulance stations, warehouses, transport depots, factories, garages and showrooms.

The Series 3000 door is a two leafed overhead folding door, hinged horizontally and rises vertically to stack in a folded position under the lintel.

Renlita Overhead Doors is a trading name of Monarch Group Pty Ltd



RENLITA SERIES 3000 FOLDAWAY DOORS



Features

- ▶ From industrial to residential, Renlita Series 3000 doors have got you covered. Each door is designed and manufactured individually using precise mathematical calculations to achieve exact counterweight balance for safety and appearance.
- ▶ We customise each project so we work in harmony with your design brief.
- ▶ The Renlita Foldaway Series 3000 counterweight balanced door is designed for industrial/commercial and domestic applications where minimum internal projection is required.
- ▶ Little headroom is necessary for this type of door.
- ▶ The doors accept a wide range of cladding and/or glazing materials and come in many colours to suit your design brief.
- ▶ When opening, the door folds along a central hinge and moves upward, coming to rest in horizontal configuration immediately below the lintel.
- ▶ Dimensions of the doors vary according to the application and each door is individually designed.
- ▶ Mathematical calculations are completed to ensure the door is correctly counter weight balanced.
- ▶ Wind loading can be a critical design factor especially in cyclone prone areas unless otherwise specified the doors are designed to resist a minimum wind loading of 0.5kPa.
- ▶ This door suits high security applications.

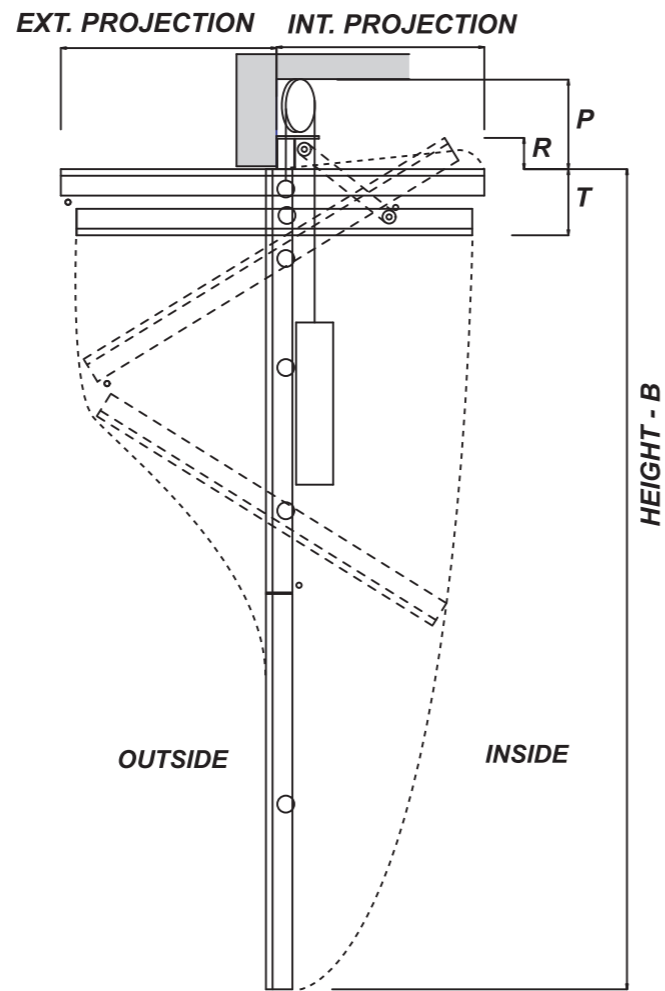

Typical Fixing Details

Jamb Details NIB Room Dimensions

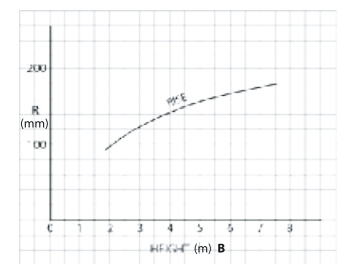
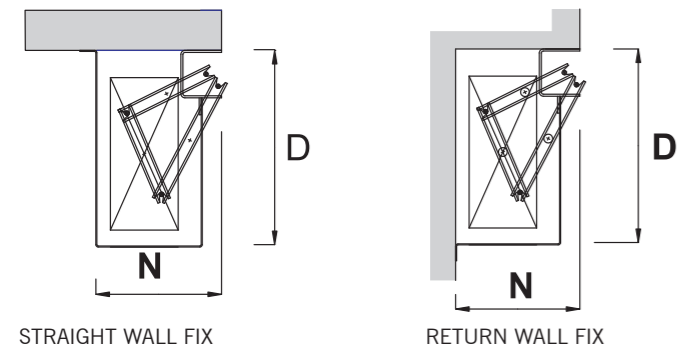

DOOR RISE

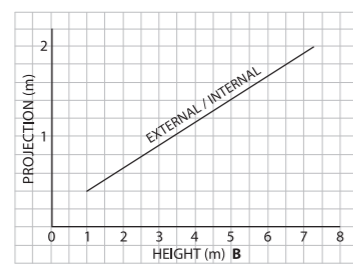

PROJECTION

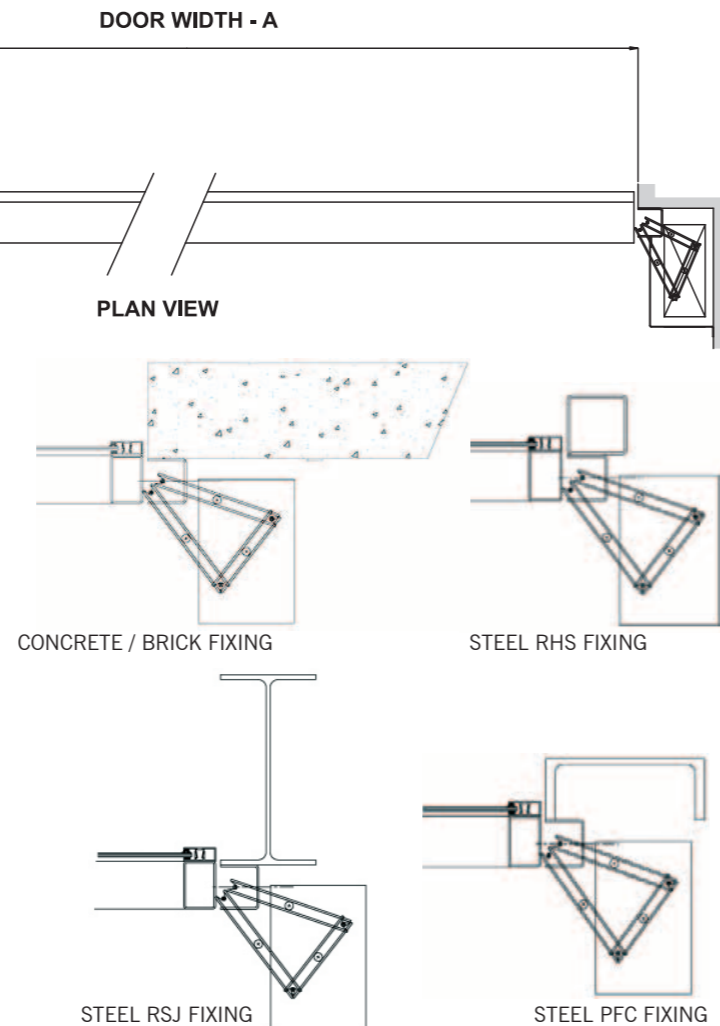

GLASS

D = Depth N = Width

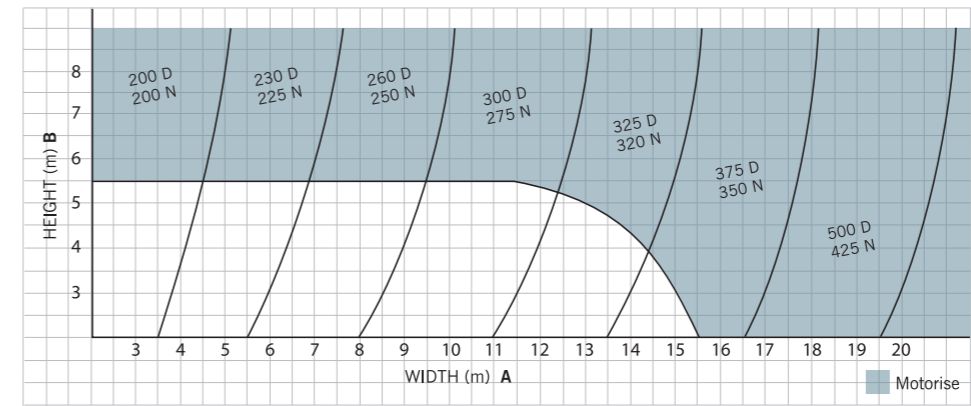

GLASS																		
A	Width (m)	3	4	5	6	7	8	9	10	11	12	13	14	15	16	17	18	19
T	Thickness (mm)	230	250	270	310	320	350	400	420	420	465	465	484	515	515	565	565	600
T	Dimensions allow for 25 deep glazing beads																	
P	Pulley HR (mm)	200	250	250	260	260	300	300	300	380	380	380	380	380	400	400	400	400
P	Minimum headroom 450 required for motorisation																	

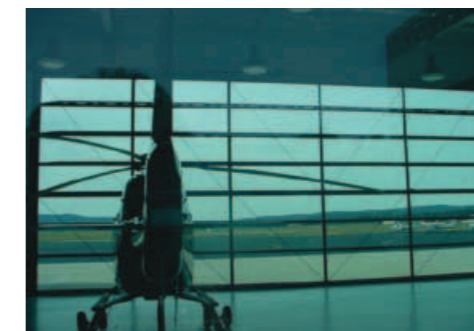

STEEL

D = Depth N = Width

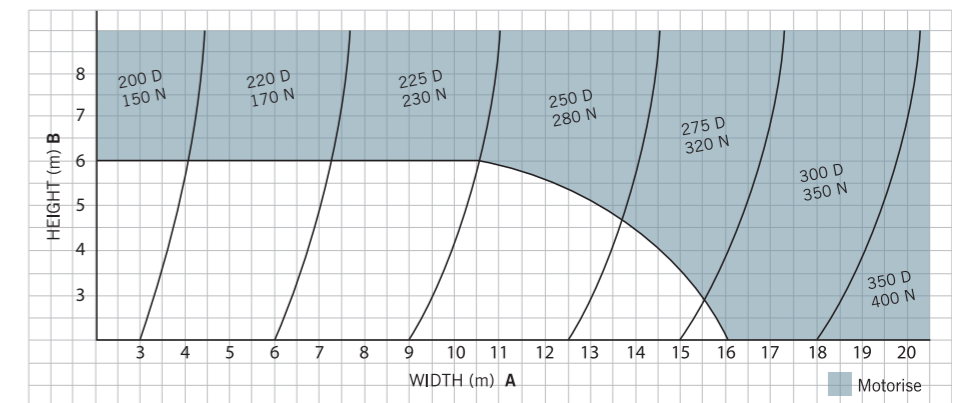

STEEL																		
A	Width (m)	3	4	5	6	7	8	9	10	11	12	13	14	15	16	17	18	19
T	Thickness (mm)	210	240	260	260	310	320	350	400	420	420	465	465	465	515	515	565	565
T	Dimensions allow for 25 Cladding Depth																	
P	Pulley HR (mm)	200	200	250	250	260	260	300	300	300	380	380	380	380	380	400	400	400
P	Minimum headroom 450 required for motorisation																	

