

Storm • Safe[™]

Home Protection Garage Doors

Why Storm • Safe[™]?

- Protect your home in cyclone-affected regions
- Independently tested to AS/NZS 4505: 2012 for C1 & C2 regions
- Features patented Guide-Lok[™] safety technology

Gliderol Storm•Safe™ Cyclone Rated Roller Doors

Cyclone Rated Windlocked Roller Door

Gliderol's Storm•Safe™ Roller Door has been uniquely designed using patented Guide-Lok® technology to provide homes in cyclone and storm prone regions with the ultimate in safety and durability.

Designed and manufactured in Australia, the Gliderol Storm•Safe Roller Door is engineered to withstand Australia's harshest conditions.

Gliderol's independently tested patented Guide-Lok™ technology integrates the function of windlock clips into the door curtain itself - eliminating unnecessary hardware resulting in maximum strength, with minimal fatigue, over the life of the door.

Complimented by 60mm deep aluminium guides, each capped with a custom designed nylon infeed, Storm•Safe's door hardware is both corrosion resistant and neater in appearance.

With state-of-the-art technology, you can be confident Gliderol's Storm•Safe Roller Door will safeguard your home, keeping your family and your property protected.

Head and Side Room Clearances

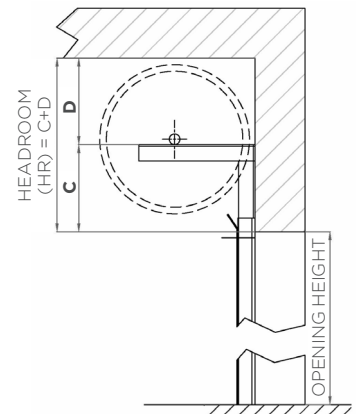
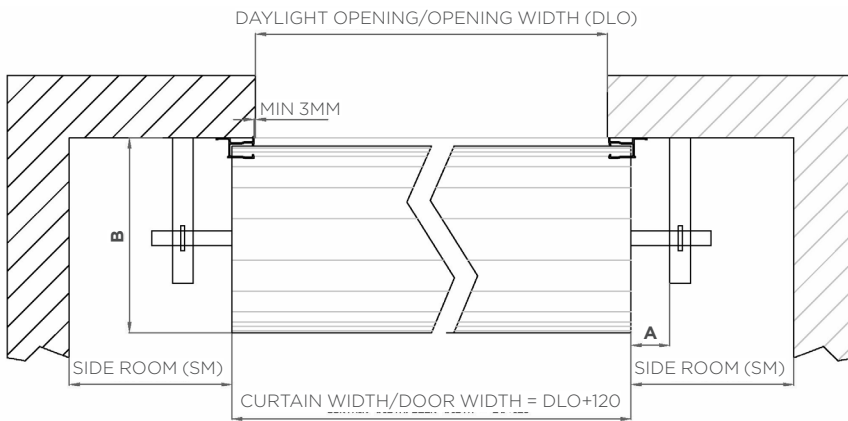

Series 'A' and 'AA' C2 Windlock Roller Doors

Minimum Dimensions							
Opening Height (mm)	Side Room SR		Head Room (HR)	A	B	C	D
	Manual	Auto					
2100	150	200	430	50	500	170	260
2400	150	200	470	50	540	190	280
2700	150	200	470	50	540	190	280
3000	150	200	510	50	560	210	300

Series 'B' Industrial C2 Windlock Roller Doors

Minimum Dimensions						
Opening Height (mm)	Side Room SR (Manual & Auto)	Head Room (HR)	A	B	C	D
Up to 3000	250	510	75	560	210	300
Up to 5000	250	550	75	580	230	320

Maximum Door Width for C1 & C2 Wind Classification

Wind Classification	Ultimate Design Wind Pressure (kPa)		Max Door Width	Max Force Fx	Max Force Fy
	Inward	Outward			
C1 & C2	2.92	-3.37	5220mm	28.87 kN/m	7.75 kN/m



Key Features & Benefits

- Independently tested & certified to AS/NZS 4505:2012
- Innovative & cyclone rated Guide-Lok™ safety technology
- Strength, quality & durability in design
- Hard-wearing & high performance
- Available in a wide range of Colorbond® colours

A Guide-Lok™ Nylon Infeed

Self lubricating nylon infeed fitted to the top of each aluminium guide facilitates proper curtain-to-guide lead-in, ensuring smooth operation every time.



B Guide-Lok™ Interlocking Curtain Recesses

Storm•Safe Roller Door curtain features interlocking recesses on both ends of each flute. This patented revolutionary system eliminates the need for cumbersome clips & hardware, resulting in a lighter, more reliable door that is easier to install & maintain.

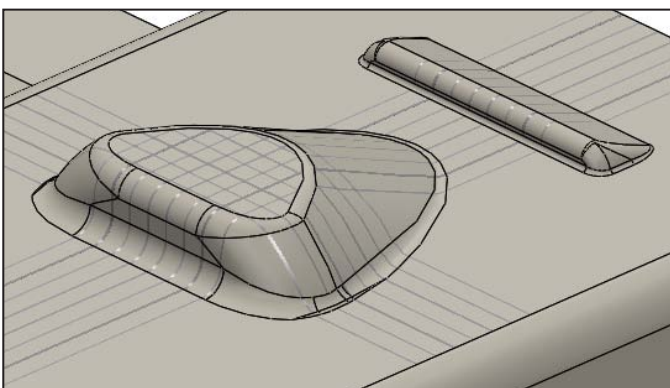

C Guide-Lok™ Aluminium Guides

Custom designed aluminium windlock guides provide increased strength, durability and rust resistance - particularly in coastal areas. Brushed aluminium finish improves on the aesthetics of tradition Roller Door hardware to provide a cleaner, neater finish.



Openers & Automation

Automatic Openers for Residential Roller Doors

Gliderol Roller Door Openers



Heavy Duty GRD+ Roller Door Opener (800N)

With its powerful drive unit neatly tucked away inside the door roll, Gliderol's GRD+ opener with Control Box offers reliable performance with style.

Features

- Suits residential roller doors up to 12m²
- Easy to use wall mounted control box
- Courtesy LED light for convenience & safety
- Patented orbital drive technology
- Safety auto reverse

Opener Kit Includes

- GRD+ drive unit (included with door)
- Control box with 2 x G+ remotes

TECHNICAL SPECIFICATION	
Power Input	220V AC 50Hz
Open/Close Force	800N
Decoding	Glide•A•Code System
Motor	24V DC
Operation	Standard Drive
Working Temp	> -20°C, < +50°C



GRD+ Dual Roller Door Opener (1000N)

Gliderol's GRD+ Dual opener with Control Box offers all the quality features of our GRD+ unit with the added strength of a powerful dual drive motor.

Features

- Suits all large residential roller doors
- Easy to use wall mounted control box
- Courtesy LED light for convenience & safety
- Patented orbital drive technology
- Safety auto reverse

Opener Kit Includes

- GRD+ drive unit (included with door)
- Control box with 2 x G+ remotes

TECHNICAL SPECIFICATION	
Power Input	220V AC 50Hz
Open/Close Force	1000N
Decoding	Glide•A•Code System
Motor	24V DC
Operation	Orbital Drive
Working Temp	> -20°C, < +50°C

Storm•Safe™ Series Colour Range



Surfmist®

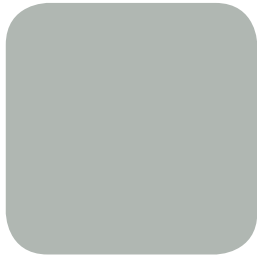

Shale Grey™



Classic Cream™



Paperbark®

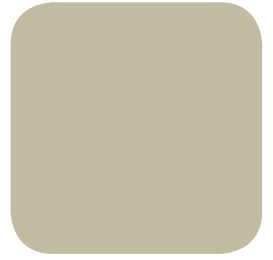

Evening Haze®



Cove™



Dune®

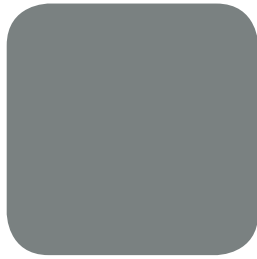

Windspray®



Gully™



Jasper®

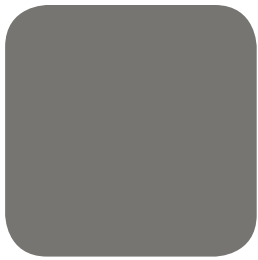

Wallaby™



Basalt™

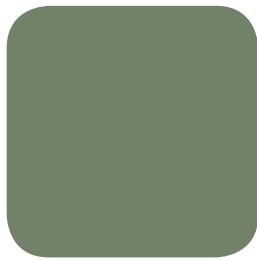

Pale Eucalypt®



Mangrove™

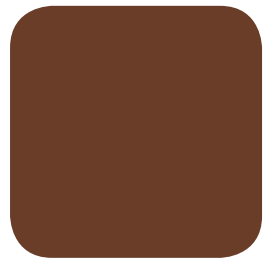

Terrain™

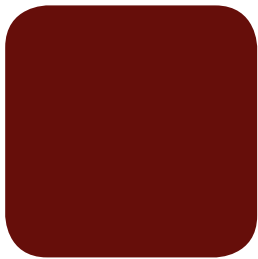

Manor Red®

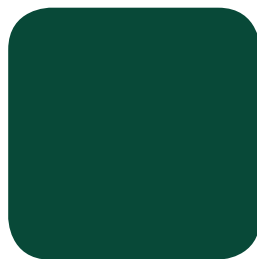

Cottage Green®

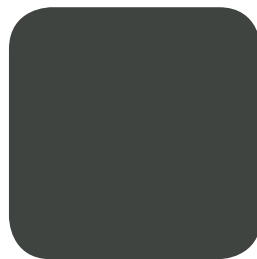

Woodland Grey®



Deep Ocean®



Ironstone®



Monument®

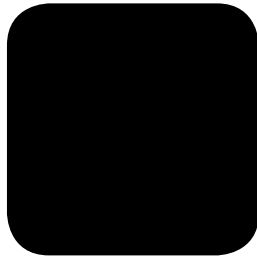

Night Sky®

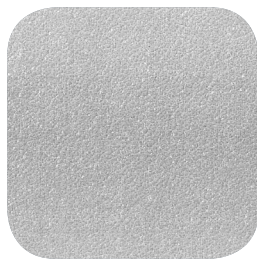

Zincalume®

Colorbond®

The COLORBOND® steel colours shown here have been reproduced to represent actual product colours as accurately as possible. However, we recommend checking your chosen colour against an actual sample of the product before purchasing as varying light conditions and limitations of the printing process may affect colour tones. COLORBOND®, BlueScope and ® colour names are registered trade marks of BlueScope Steel Limited. ™ colour names are trade marks of BlueScope Steel Limited. COLORBOND®, BlueScope and ® colour names are registered trade marks and ™ colour names are trade marks of BlueScope Steel Limited.

**Call your local Gliderol Office
on 1300 799 144**

Or email us at
sales@gliderol.com.au